

Application Note: Functional description for 3 Pin Digital PIR USB interface evaluation module

MOS (PTY) LTD.

Microsystems On Silicon

Member of ELMOS Semiconductor AG

PCB Version M931

The E931.08 PIR A2D MURATA is used to demonstrate the capability of the E931.08 using a MURATA SMD PIR detector. The microcontroller on the module reads PIR voltage and Temperature information on every interrupt and passes it on to the USB port. The module can be used get familiar with the E931.08 or to characterise various traditional SMD PIR detectors from Murata.

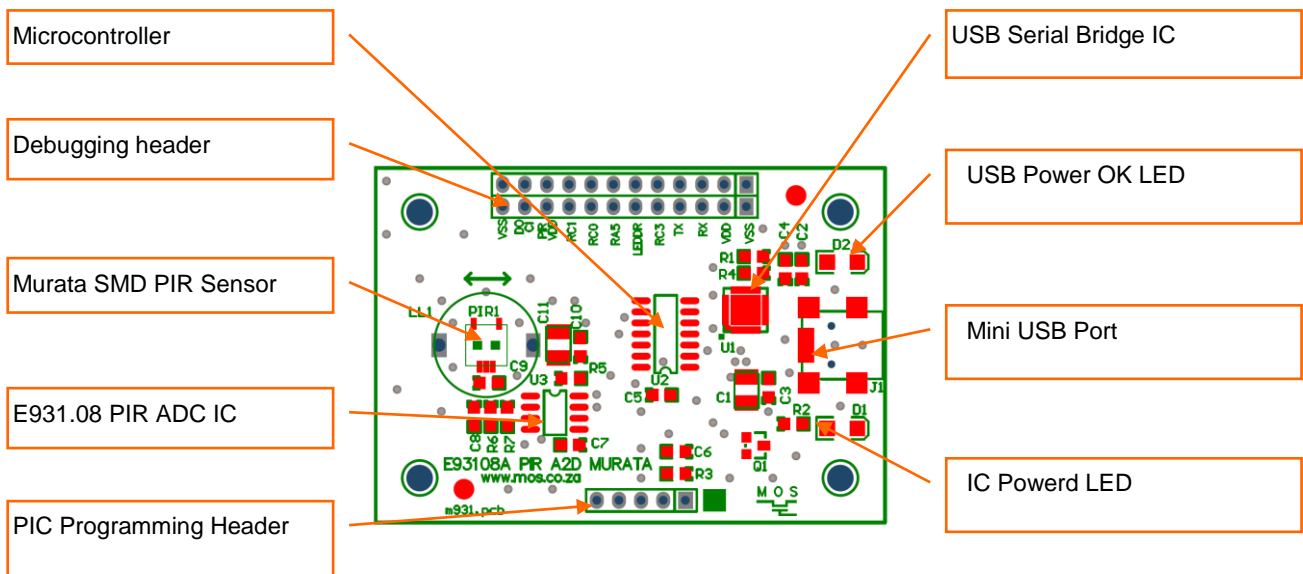

Notes:

1. The module is not protected against ESD, avoid potential difference between yourself and the module before use.

Application Note: Functional description for 3 Pin Digital PIR USB interface evaluation module

PCB Version M931

Module Description and Connection

1. Power Supply

The SiLab USB to UART Bridge internal regulator generates a stable 3.3V for the circuitry on the module.

2. Detector Readout

The Microchip PIC reads the data from the digital detector, through the DOCI interface.

3. LED Indicators

A power LED D2 indicates that the module is connected to the USB port. LED D1 is controlled by the processor; it is used to indicate if the E931.08 is powered.

4. Programming connector

J2 is a programming connector that can be used to reprogram the MCU. The pins on the programming connector are compatible to the MPLAB ICD2 LE, PICKit 2 and PICKit 3 programmers. Pins 4 and 5 are used for mode setting inputs upon start-up of the module.

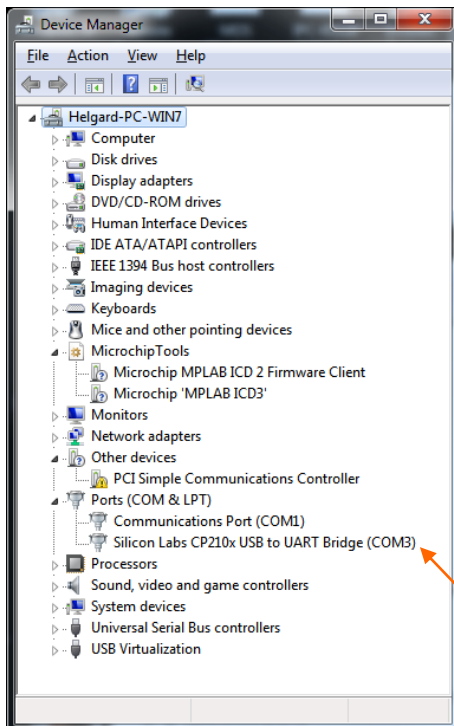

5. USB interface with a Personal Computer (PC)

A CP2102-GM USB to UART Bridge interfaces between a PC and the UART on the MCU.

It may be necessary to install an appropriate driver on the PC if it is not handled automatically by the operating system. The driver can be found here:

<http://www.silabs.com/products/mcu/Pages/USBtoUARTBridgeVCPDrivers.aspx>

After the driver is installed correctly and the module is plugged in to a USB port on the PC, an additional entry in the Ports category of the Device Manager will show up.

Make a note of the new Com Port number that is assigned to the module, since it will have to be specified when using the PC Scope software or the terminal software.

Port used by module

Application Note: Functional description for 3 Pin Digital PIR USB interface evaluation module

PCB Version M931

Software version on Module

This document is valid for software version Compiled on 17-May-12 11:12:48 and later.

PC Interface

The module interfaces to a PC via a serial to USB converter IC. The Silabs driver software installed on the PC takes creates a virtual serial port again. There is software needed on the PC to make sense of the data from the module. The options available are the use of a terminal program or the MOS Scope Software.

A serial terminal program such as Hyper Terminal or Putty can be used to see and possibly log the actual register values in plain text.

If a direct graphical display of the data is preferred, the MOS Scope software can be used. The MOS Scope software needs a configuration file for the particular module used, ensure that the file name and the module number match.

The MOS Scope SW outputs data to the PC in a binary format and the terminal programs uses standard ASCII data. The ASCII output format is selected with a jumper on the programming connector; the binary format does not need any jumpers.

In terminal mode the jumper is inserted between VSS and Pin 13 on the PIC. Sensing of this mode is only done on a reset of the module, power up or MCU reset.

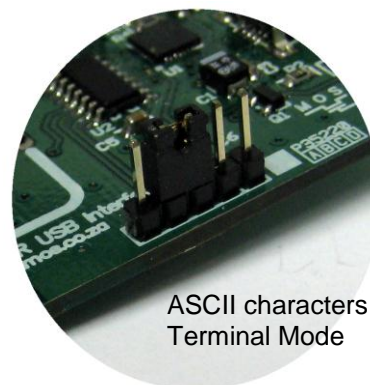

Application Note: Functional description for 3 Pin Digital PIR USB interface evaluation module

PCB Version M931

Terminal interface

Insert the module in the USB port; Give it a couple of moments for the driver to load and the port to be initialized.

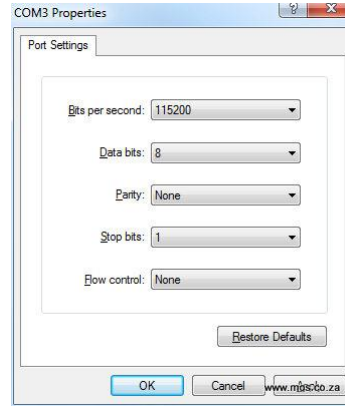

The port settings on the terminal program must be as follows:

115200b/s, 8 data bits, 1 start bit, 1 stop bit, no parity, no flow control

In Terminal Mode the information from the MCU are transferred as ASCII characters and end with a <LF><CR> combination.

In Putty the setup screens would like as follows:

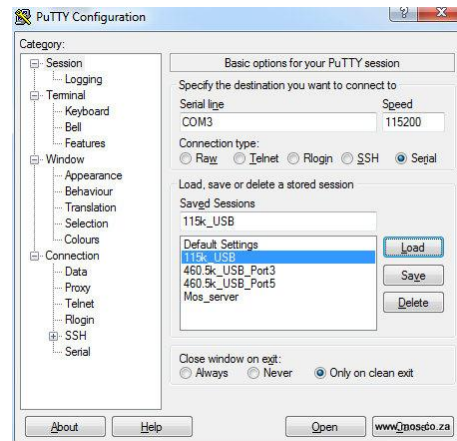
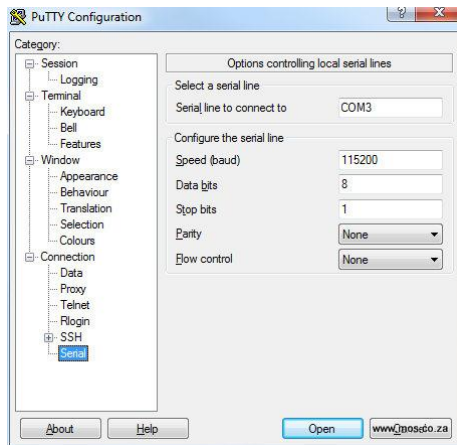

Terminal software should be running now.

Ensure that a 3 pin Digital PIR is inserted in the module.

The terminal window should be open and a couple of coulombs of data should be scrolling from the bottom of the window at this stage, Press 'R' to restart the SW on the module.

The specific Digital PIR that is inserted will be identified automatically upon restart of the program running on the MCU. The correct registers will now be read continuously from the detector.

The terminal window will show a couple of coulombs of data depending on the type of detector used.

Application Note: Functional description for 3 Pin Digital PIR USB interface evaluation module

PCB Version M931

Data is always shown in the sequence PIR register, Temperature register, Time between readings.

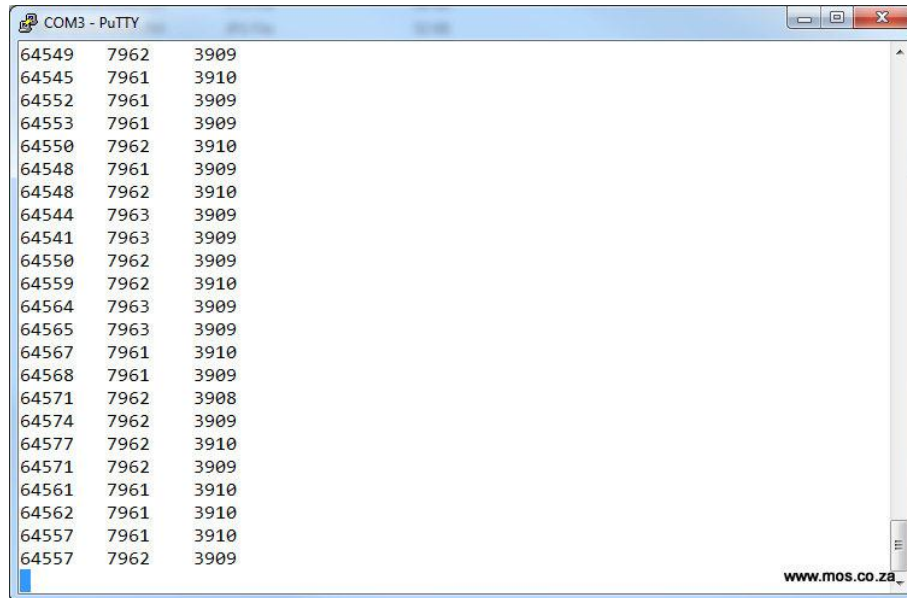

The following options are supported on this software version and are selected by pressing a single character on the keyboard.

Key controls options that are available as follows:

Key	Action	E931.08
T	Display Temperature On/Off	Yes
t	Display time between measurements	Yes
space	Detector power On/Off	Yes
c	Transfer/Stop transfer data to PC	Yes
f	#Enable/Disable HP Filter on PIR data	Yes
R	Reset the MCU	Yes
A	#Enable/Disable AC PIR data	No
V	#Enable/Disable Voltage or Counts graph display (scope mode)	Yes
v	SW Version	Yes
q	Display the menu message	Yes

Application Note: Functional description for 3 Pin Digital PIR USB interface evaluation module

PCB Version M931

The 'q' was pressed and the register data is not displayed any more, the options menu is displayed, to see the register reads press the "c".

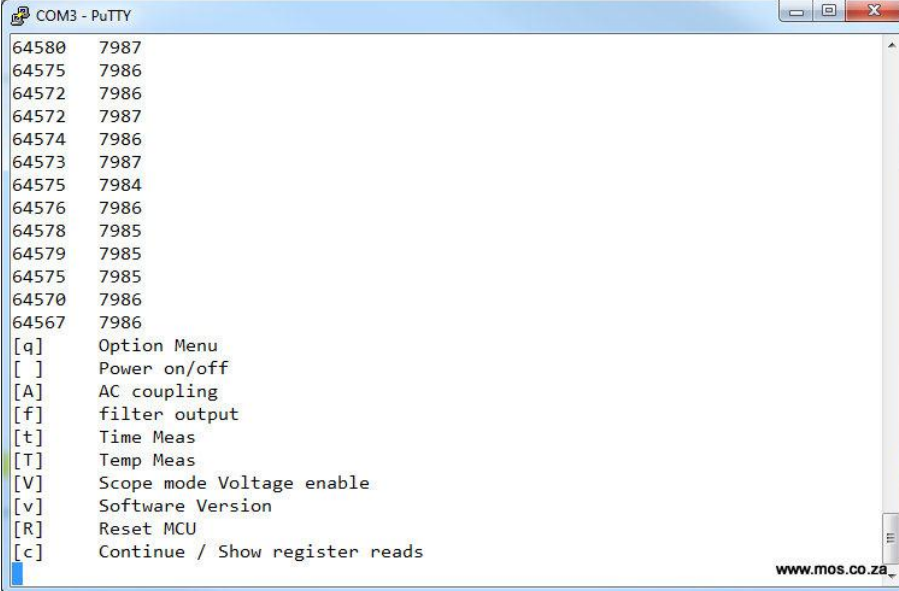

```
COM3 - PuTTY
64580 7987
64575 7986
64572 7986
64572 7987
64574 7986
64573 7987
64575 7984
64576 7986
64578 7985
64579 7985
64575 7985
64570 7986
64567 7986
[q] Option Menu
[ ] Power on/off
[A] AC coupling
[f] filter output
[t] Time Meas
[T] Temp Meas
[V] Scope mode Voltage enable
[v] Software Version
[R] Reset MCU
[c] Continue / Show register reads
www.mos.co.za
```

The 'f' was pressed to show the filtered ADC values. Software filters are implemented on the module for all devices except the E931.08.



```
COM3 - PuTTY
-8 7988
-3 7989
-1 7990
-6 7989
-9 7989
-7 7989
-10 7988
-8 7989
-7 7989
2 7990
6 7990
0 7989
-8 7989
-3 7989
1 7990
9 7990
10 7990
9 7989
12 7989
14 7989
12 7989
11 7989
12 7989
www.mos.co.za
```

Application Note: Functional description for 3 Pin Digital PIR USB interface evaluation module

PCB Version M931

MOS Scope Software

The operation of the MOS Scope SW is described in a different document that is supplied with the software. Key issues regarding the use of this module only are highlighted below.

In Scope mode (selected by removing all jumpers upon start-up) the information from the MCU are transferred as a binary packet to the PC. For the MOS Scope SW to function correctly the correct module configuration file must be loaded and the correct baud rate and port must be selected in the configuration settings.

The module number is usually the last 4 characters of the "Data Config Mxxx.csv" file in this case the config file will be called "Data Config M952.csv"

Connect the module to a USB port on the PC.
Start the Scope software (usually a icon on the desktop)
Click on the Data Config Tab, now click on File, select Open Config file.
Load the correct file for the module.

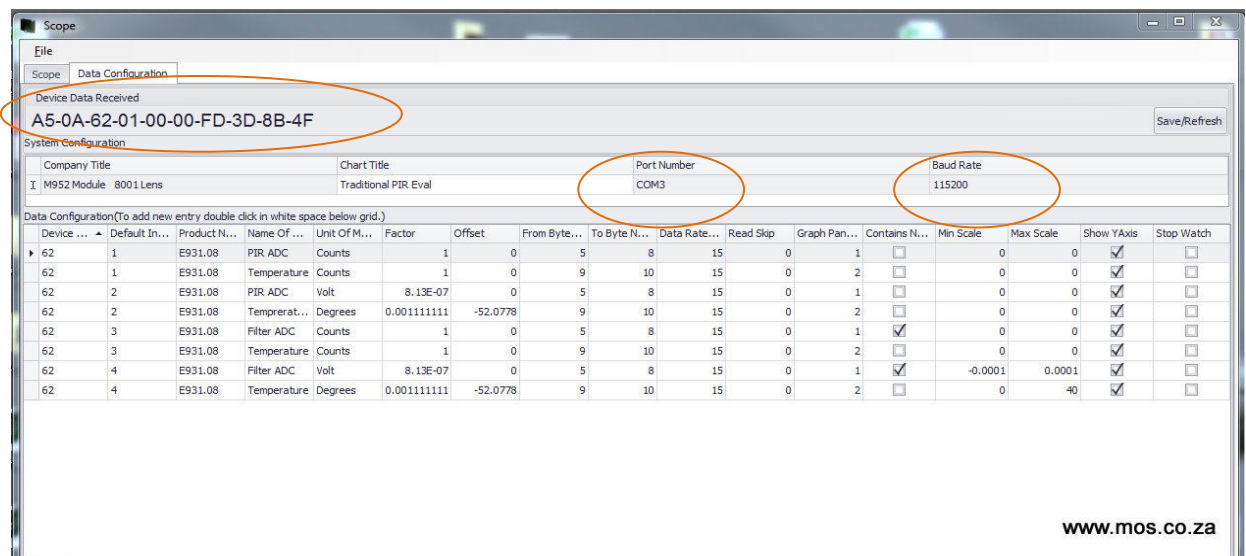

Ensure that the correct Port and baud rate is also set for the module.

Click Save/Refresh

Wait a couple of seconds

Each time the Save/Refresh button is clicked the Device Data Received should change, this shows that the data from the module is received correctly.

Click on the Scope Tab to see the graphical data.

Press Start

The data from the module is now supposed to be displayed on the graph.

Application Note: Functional description for 3 Pin Digital PIR USB interface evaluation module

PCB Version M931

MOS (PTY) LTD.

Microsystems On Silicon

Member of ELMOS Semiconductor AG

Hardware

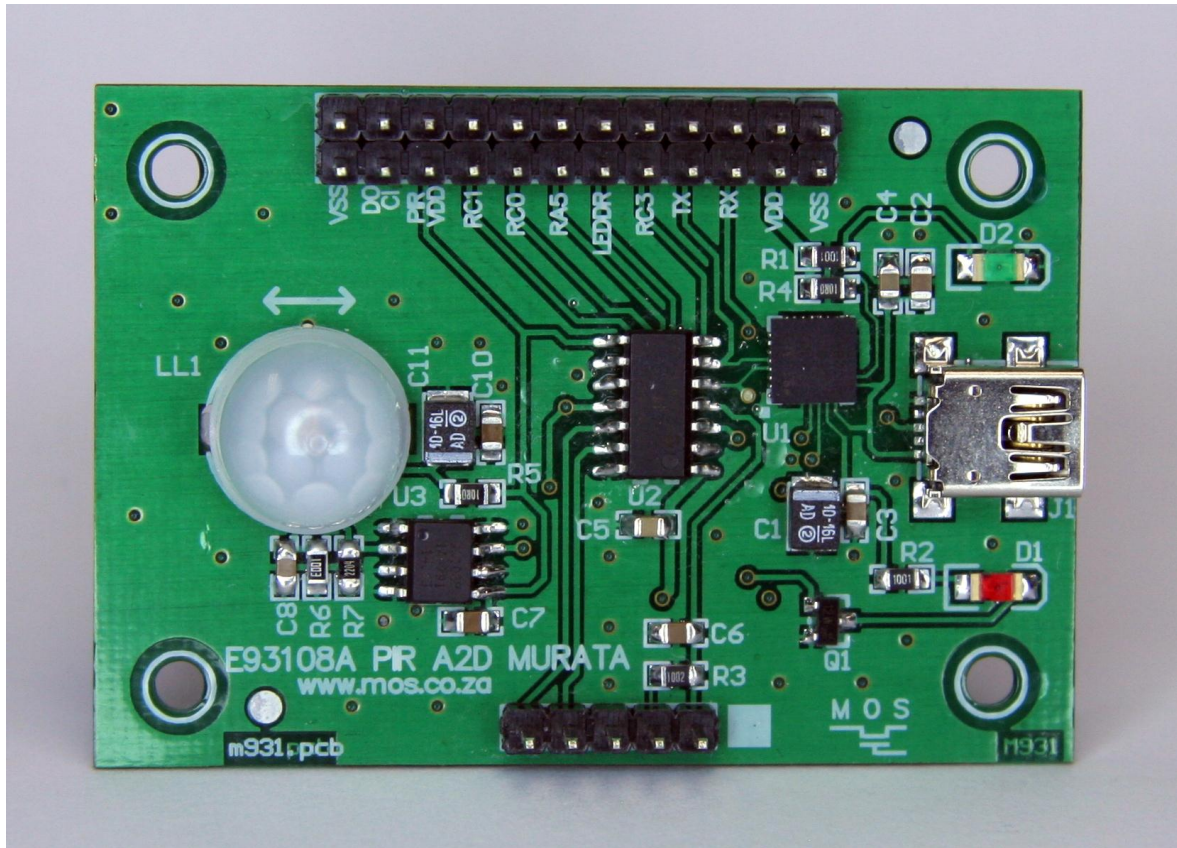

Contact Information

Microsystems On Silicon (Pty) Ltd.

Pretoria, South Africa

Tel: +27 12 998 4147

Fax: +27 12 998 4217

email: sales@mos.co.za

Visit our website for the latest information

Application Note: Functional description for 3 Pin Digital PIR USB interface evaluation module

PCB Version M931

MOS (PTY) LTD.

Microsystems On Silicon
Member of ELMOS Semiconductor AG

